

PG&E Substation Signage for Third-Party Interconnections

SUMMARY

This utility procedure provides guidance on substation signage for third-party transmission interconnections to the PG&E system.

This procedure supplements [Utility Manual TD-1013M, Transmission Interconnection Handbook \(TIH\)](#).

Level of Use: Informational Use

TARGET AUDIENCE

This procedure targets internal and external personnel involved with third-party interconnections.

SAFETY

This procedure describes the types of signs and the required sizes, colors, and wording used to alert personnel about additional dangers created by third-party generators in substations.

BEFORE YOU START

OBTAIN security clearances to enter a station.

TABLE OF CONTENTS

SECTION	TITLE	PAGE
1	Background.....	1
2	General Instructions	2
3	Target Plates.....	3
4	PG&E Equipment-Identification Signs	5
5	PG&E Metering Facility Identification Sign	6
6	Generator Onsite Caution Sign	10

PROCEDURE STEPS

1 Background

Standardizing signs provides consistency in all PG&E-connected facilities, making it easier for operation, maintenance, and other personnel to operate, maintain, and safely visit a substation facility. Additionally, exterior safety signs alert the public about imminent hazards.

PG&E Substation Signage for Third-Party Interconnections

2 General Instructions

- 2.1 ENSURE that the following precautions are taken when placing signs in and around substation facilities:
1. All signs are in place before the pre-parallel inspection and are verified by PG&E personnel before energizing a third-party facility.
 2. Third-party personnel SUBMIT signage specifications (i.e., drawings) before pre-parallel inspection.
 - a. These drawing should be submitted in conjunction with the facility schematics, as shown in the [TIH, Section G2, "Protection and Control Requirements for Transmission Generation Entities,"](#) Table G2.1, "Document Submittals," on Page G2-4.
 3. Signs are clear and concise in their wording, legible, durable, and accurate.
 4. Signs are created as described in PG&E standards (i.e., size, standard wording, color, and material).
- 2.2 [Figure 1, "Overview of Required Signage,"](#) on Page 3, shows the location of signs with respect to the fence, gate, and other key interconnection equipment.
1. Detailed information for each sign in [Figure 1](#) is found in the sections and subsections correlating the numbers on the drawing.

NOTE:

For the example signs in [Figure 1](#), information inside the brackets, "[...]" is site specific.

PG&E Substation Signage for Third-Party Interconnections

2.2 (continued)

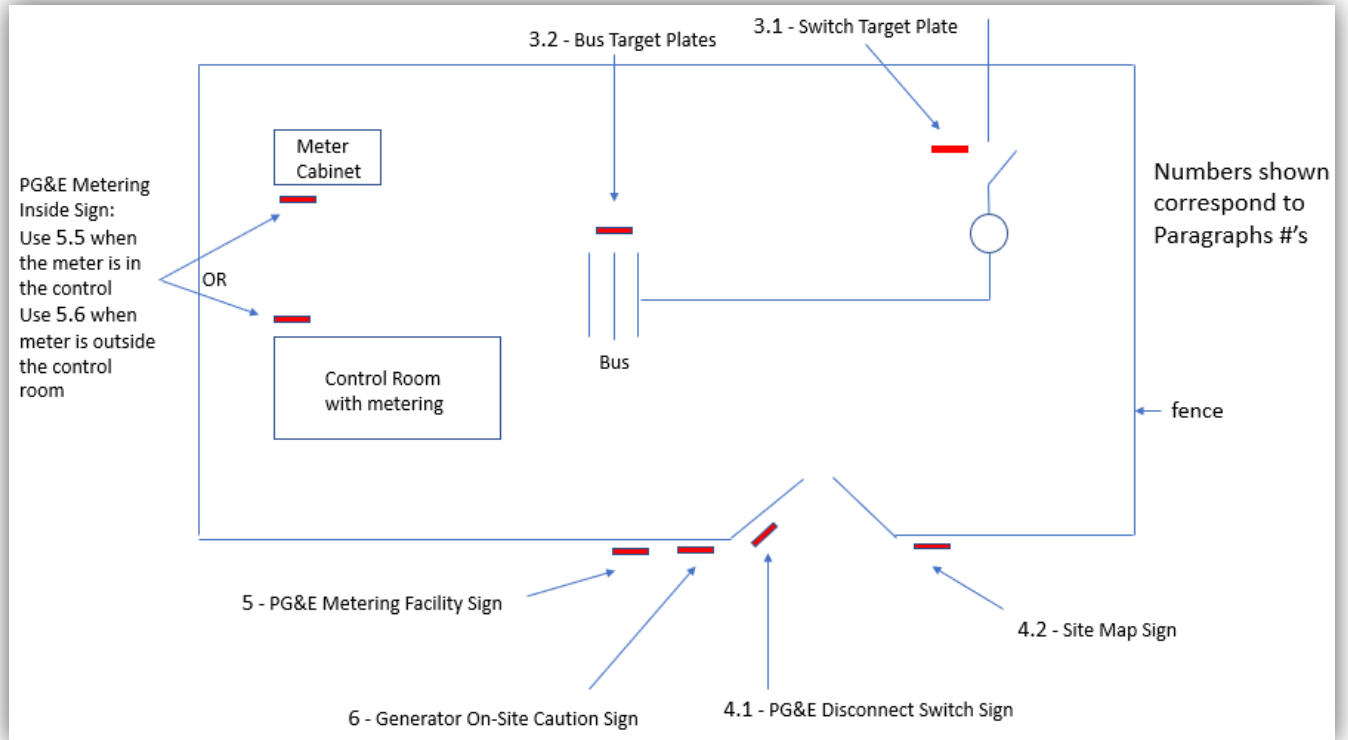

Figure 1. Overview of Required Signage

3 Target Plates

3.1 Switch Target Plate

1. IF the facility has multiple feeds with multiple, separate disconnect switches, THEN each disconnect requires a separate switch target plate. (SEE [Figure 2, "Example of a Switch Target Plate,"](#) on Page 4.)

PG&E Substation Signage for Third-Party Interconnections

3.1 (continued)

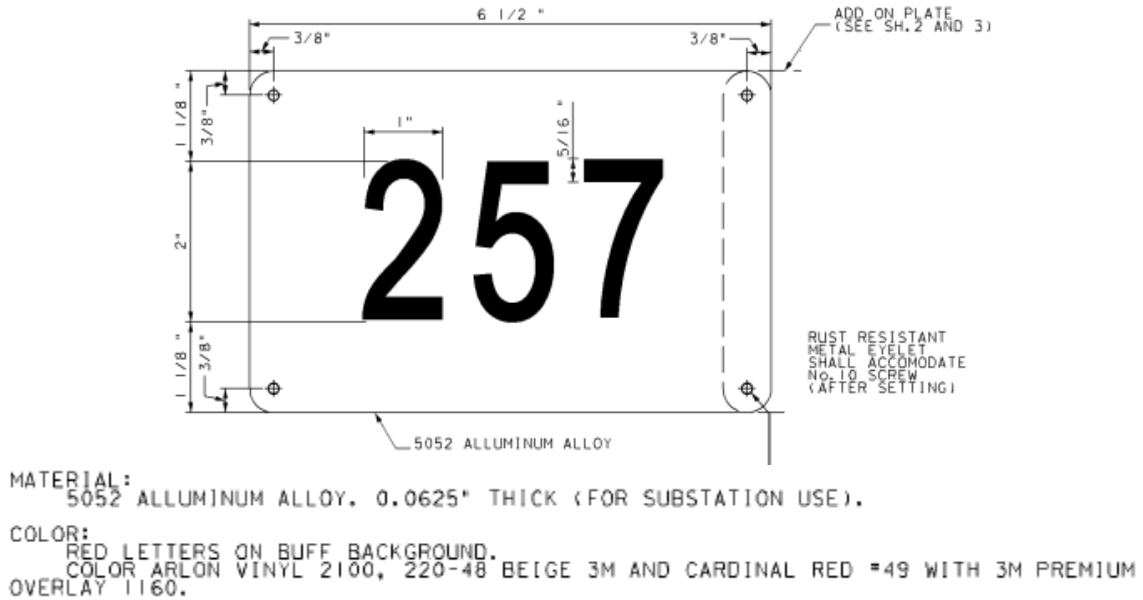

Figure 2. Example of a Switch Target Plate

3.2 Bus Target Plates

1. USE the bus target plate to indicate the phases of the lines and busses in facilities.
2. ATTACH the bus target plate on the point of interconnection, secondary test points, each side of the dead-end structure, and locations where phase rotation changes.
3. SEE [Figure 3](#) below for a 3 1/4-inch x 3 1/4-inch bus identification sign using #3 venetian red letters on a #1 buff background.

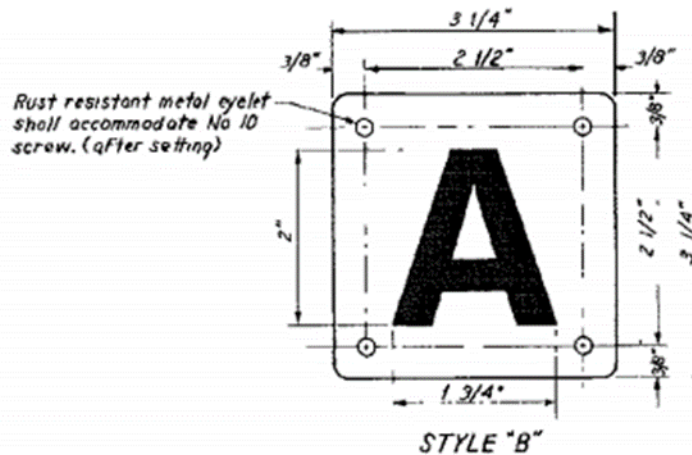

Figure 3. Example of a Bus Target Plate

PG&E Substation Signage for Third-Party Interconnections

4 PG&E Equipment-Identification Signs

4.1 PG&E Disconnect Switch Sign

1. All disconnect switches require a PG&E disconnect switch sign as described in the [TIH](#).
2. ATTACH the sign on all interconnection facilities at the substation main gate.
3. SEE [Figure 4](#) below for the wording used on a 10-inch x 14-inch disconnect switch sign with black lettering on a white background.

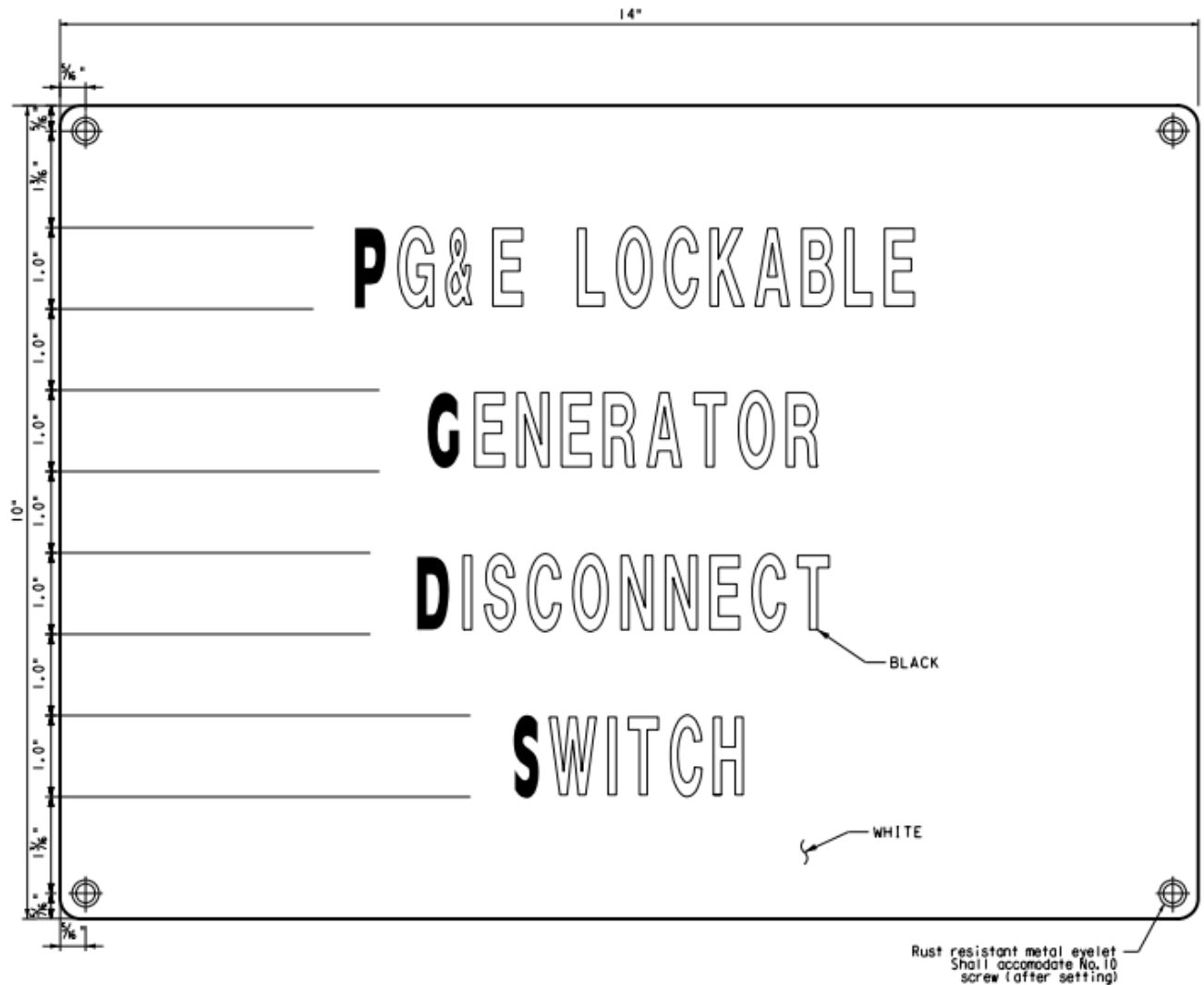

Figure 4. Wording for a PG&E Disconnect Switch Sign

PG&E Substation Signage for Third-Party Interconnections

4.2 Site Map Sign

1. Some sites may require additional signage when the interconnection facility is not accessible directly from a county-maintained road or separately gated entrance (e.g., requires personnel to drive through generation facilities such as battery storage areas or photovoltaic [PV] arrays to reach the interconnection facility).
2. ATTACH the site map sign at each entrance to the facility.
 - a. IF there are multiple entrances,

THEN each entrance must have a sign.

EXAMPLE: POST one sign at the entrance to the generation facility AND one sign to the entrance of the substation located within the generation facility.
3. ENSURE that the site map sign specifies the physical location of the PG&E meter disconnect switch (using the standard metering symbol) and identifies the disconnect switch number.
 - a. IF the interconnection facility is not near the site map sign,

THEN INCLUDE the global positioning system (GPS) coordinates AND/OR directions to the interconnection facility.
4. The site map sign must be clear and easy to read from a distance.
 - a. ENSURE that personnel can read the site map sign while sitting on the driver's side of a car or truck at the entrance.
 - b. There are no specific requirements; however, symbols and words on site map signs usually are black on a white background.

5 PG&E Metering Facility Identification Sign

- 5.1 ATTACH PG&E metering facility identification signs on all entrances to the substation, power plant, generation facility, AND/OR control room.
 1. The signs provide site-specific information to PG&E personnel entering the premises.
 2. The signs must include the following information:
 - Project name
 - Site address
 - Emergency contact information
 - Megawatts size and type of generation
 - Highest voltage in substation

PG&E Substation Signage for Third-Party Interconnections

5.1 (continued)

3. A 14-inch x 10-inch sign is recommended.
4. SEE [Figure 5](#) below for an example of a PG&E metering facility identification sign required at facility entrances.

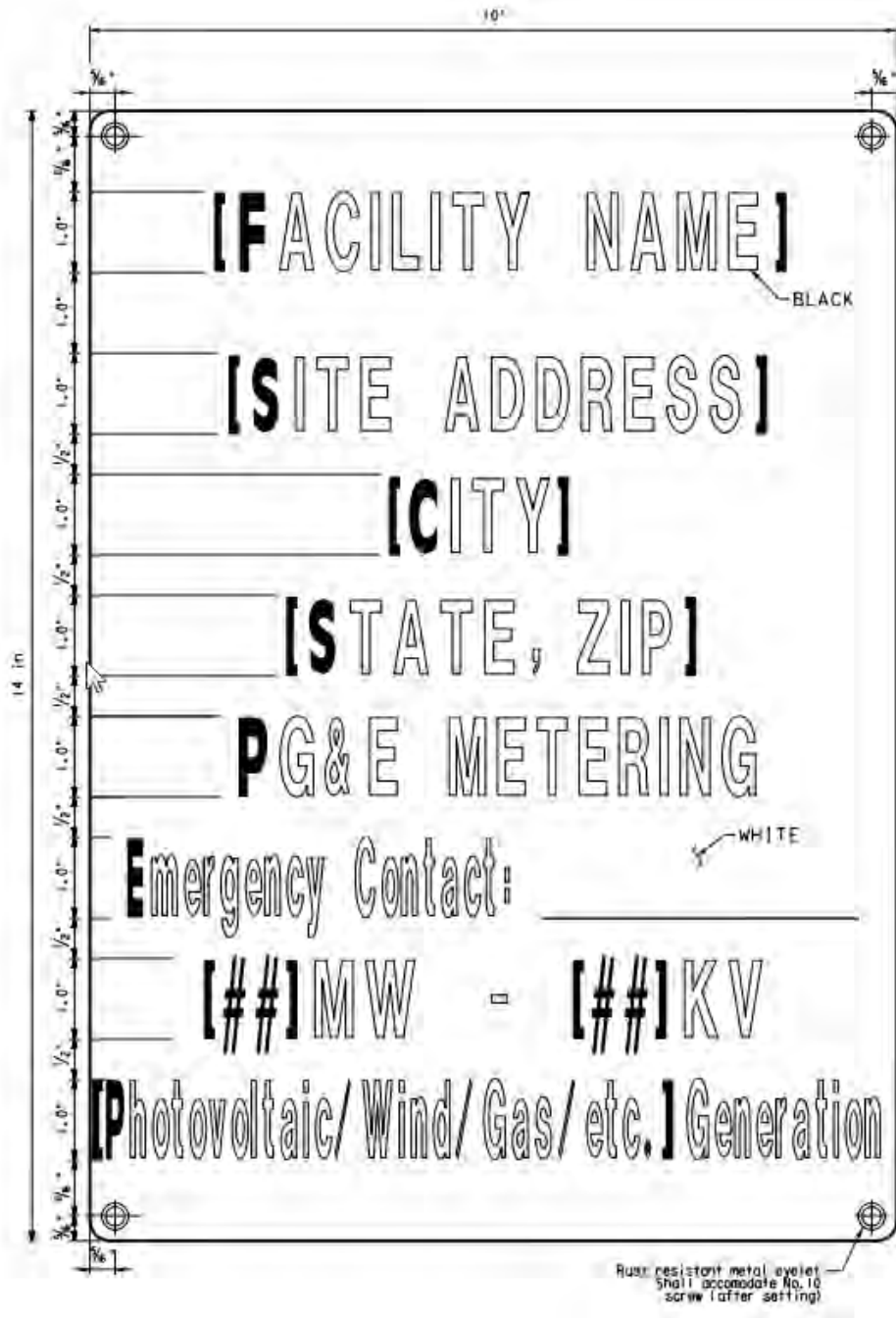

Figure 5. Example Metering Facility Identification Sign

PG&E Substation Signage for Third-Party Interconnections

- 5.2 IF the meter is installed in a control room,
 THEN USE the words “PG&E METERING INSIDE” on the sign,
 AND USE black letters on a white background. (SEE [Figure 6](#) below.)

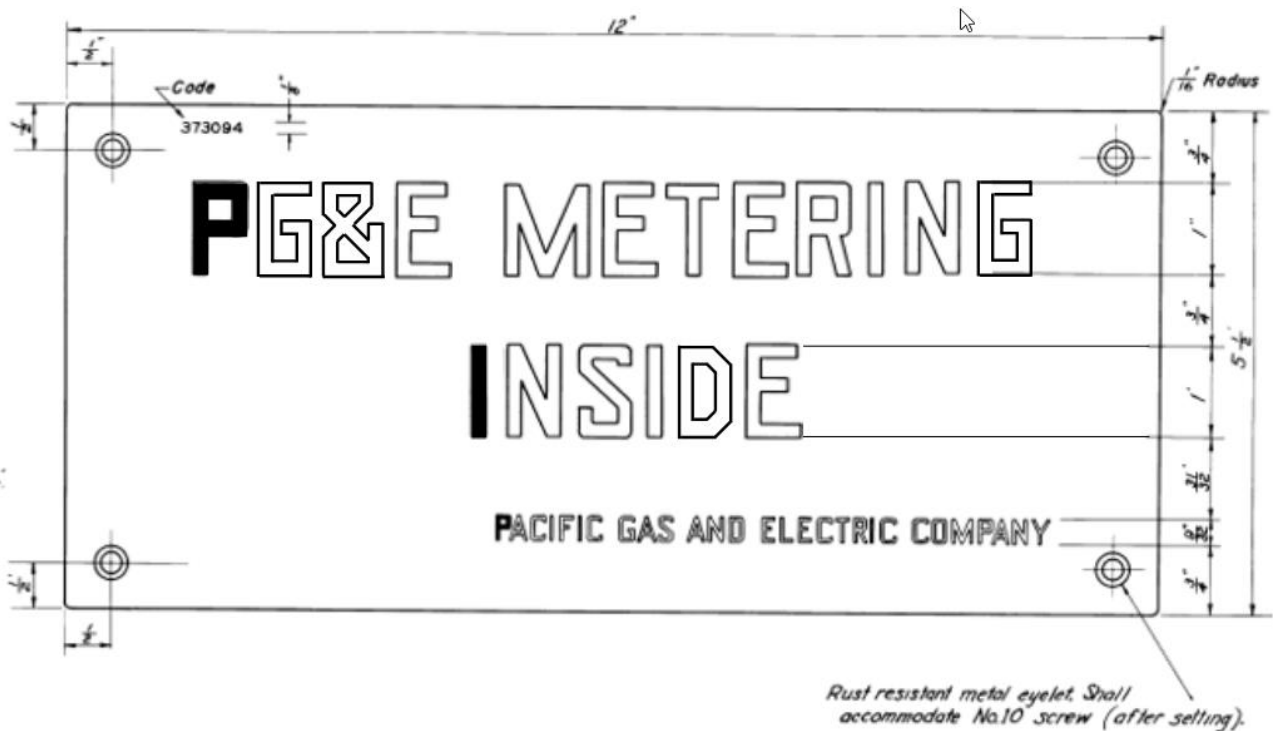

Figure 6. Example Metering Control Room Identification Sign

- 5.3 IF the meter is not in the control room,
 THEN a separate metering sign is required.
1. USE this sign to identify PG&E metering.
 2. INCLUDE the following information on the sign:
 - Facility name
 - Site address
 - The words “PG&E METERING INSIDE”
 - Megawatt size and type of generation
 - Highest voltage in substation

PG&E Substation Signage for Third-Party Interconnections

5.3 (continued)

3. ATTACH the metering facility sign on the metering cabinet door (i.e., PG&E / California Independent System Operator [CAISO] metering cabinet) AND the metering transformer junction box on the structure.
4. USE black letters on a white background. (SEE [Figure 7](#) below for an example of a non-control-room metering sign.)

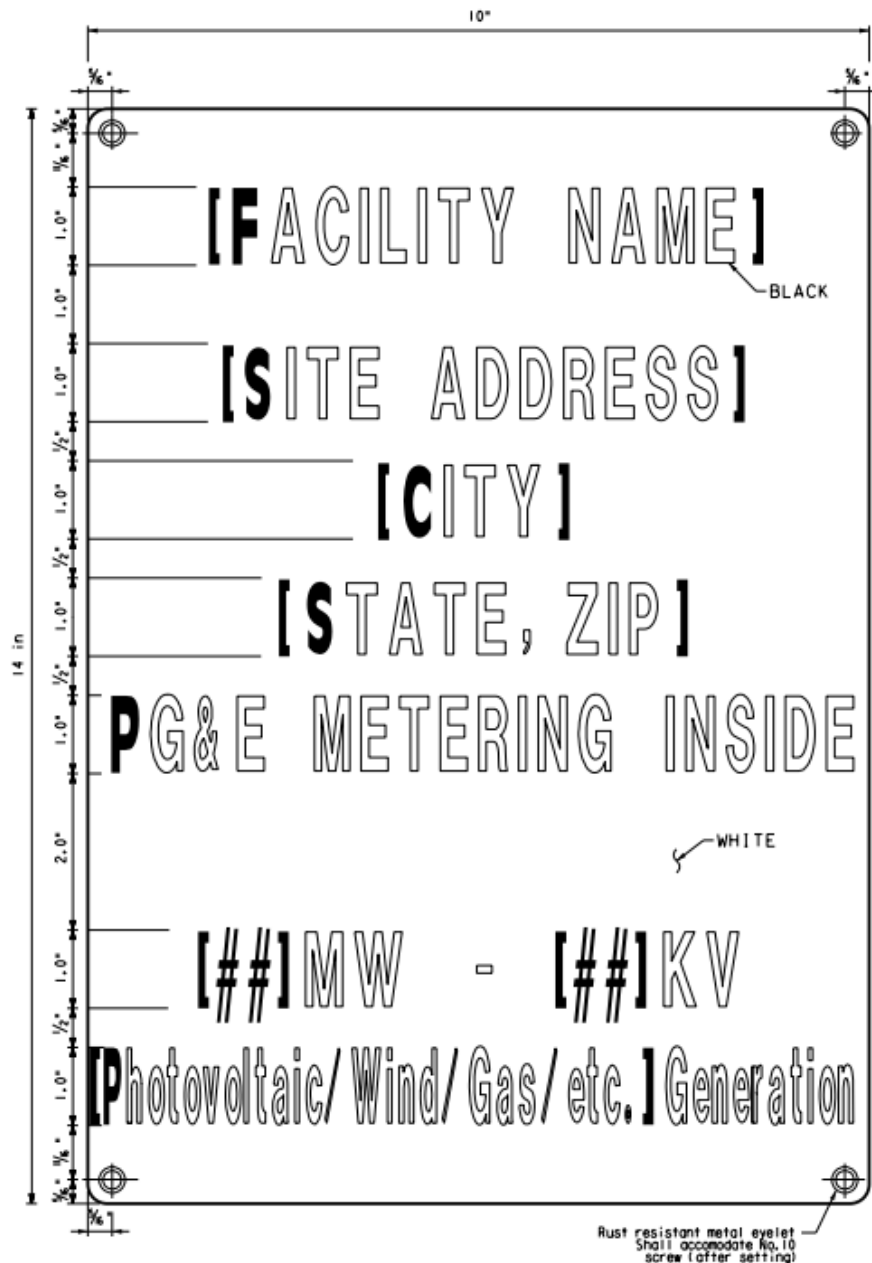

Figure 7. Non-Control Room Metering Sign

PG&E Substation Signage for Third-Party Interconnections

6 Generator Onsite Caution Sign

6.1 ATTACH a generator onsite caution sign at each entrance to the facility.

1. IF there are multiple entrances,
 THEN each entrance must have a sign.

EXAMPLE: POST one at the entrance to the generation facility AND one at the entrance to the substation within the generation facility.

6.2 USE the wording shown in [Figure 8](#) below for interconnections with single generator disconnects. Also, FOLLOW the guidelines for required colors:

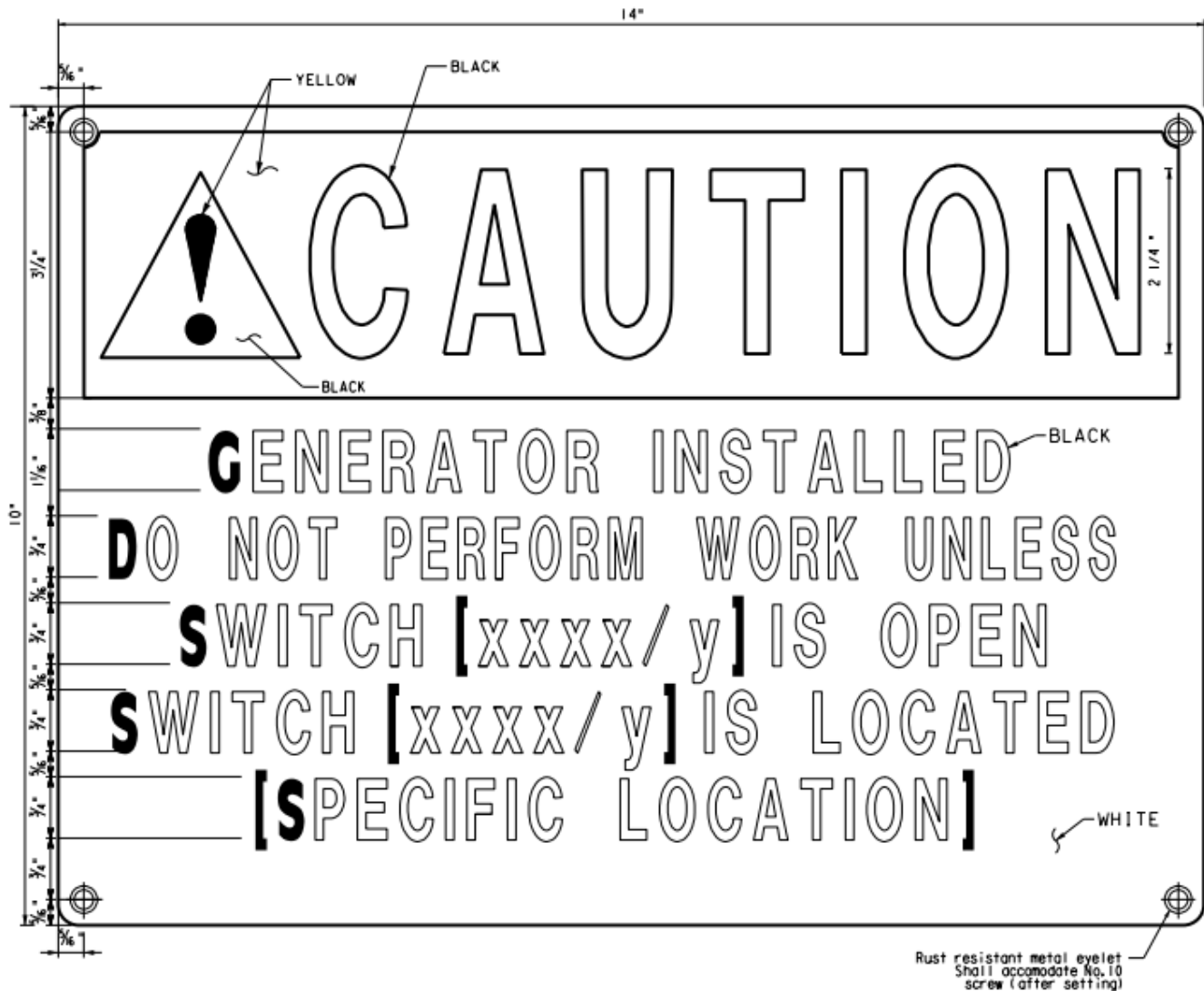

Figure 8. Generator Onsite Caution Sign

PG&E Substation Signage for Third-Party Interconnections

- 6.3 For interconnections using multiple generator disconnects, INCLUDE the following text in the sign shown in [Figure 8, "Generator Onsite Caution Sign,"](#) on Page 10:

"THIS SYSTEM HAS [x] GENERATOR DISCONNECTS. [BOTH/ALL] DISCONNECTS MUST BE OPENED TO ISOLATE THE SYSTEM."

END of Instructions

DEFINITIONS

NA

IMPLEMENTATION RESPONSIBILITIES

The TIH Committee lead publishes this procedure so that it is made public so all entities seeking to interconnect with PG&E will have the necessary information to do so.

Substation test personnel confirm that proper signage is in place before beginning commercial operation.

GOVERNING DOCUMENT

[Utility Manual TD-1013M, Transmission Interconnection Handbook](#)

COMPLIANCE REQUIREMENT / REGULATORY COMMITMENT

Records and Information Management:

Information or records generated by this procedure must be managed in accordance with the Enterprise Records and Information (ERIM) program policy, standards, and Enterprise Records Retention Schedule (ERRS). Refer to [GOV-7101S, "Enterprise Records and Information Management Standard,"](#) and related standards. Management of records includes, but is not limited to:

- Integrity
- Storage
- Retention and disposition
- Classification and protection

The [TIH](#) is mandated by CAISO to be available to the public.

PG&E Substation Signage for Third-Party Interconnections

REFERENCE DOCUMENTS

Developmental References:

[Engineering Design Criteria 073118, "Signage"](#)

[Numbered Document 454092, "Signs, Nameplates, and Supports for Transmission and Distribution Substations"](#)

Supplemental References:

NA

APPENDICES

NA

ATTACHMENTS

NA

DOCUMENT REVISION

This utility procedure cancels and supersedes Utility Bulletin TD-1013B-005, "PG&E Substation Signage for 3rd Party Interconnections," issued 03/26/2019.

DOCUMENT APPROVER

Rama Reddy, Manager

DOCUMENT OWNER

Rama Reddy, Manager

DOCUMENT CONTACT

Stan Cramer, Senior Consulting Engineer

REVISION NOTES

Where?	What Changed?
NA	This new utility procedure replaces a bulletin of the same name.