



APPLICATION OF UNDERGROUND DISTRIBUTION TRANSFORMERS 062111

Asset Type: Electric Distribution	Function: Construction
Issued by: Michael Thibault (MLTC) <i>[Signature]</i>	Date: 11-01-18

Rev. #25: This document replaces PG&E Document 062111, Rev. #24. For a description of the changes, see Page 26.

Purpose and Scope

This document provides a convenient reference for the types of transformers that are purchasable and used for underground distribution. The available voltages and kVA ratings are indicated along with the applicable codes to facilitate ordering.

General Information

1. To conserve space and avoid overlap with other documents, the description of transformers shown has been shortened. Individual characteristics of these transformers such as dimensions, accessories, and protection can be determined by making reference to the application documents.
2. Application
 - A. Single-Phase: The standard transformer for single-phase service is the Style DF-LB, single-phase, pad-mounted transformer (see Table 1 through Table 3 on Page 5). The 25 kVA through 100 kVA sizes are used for new construction. The 167 kVA size is reserved for replacement use, to solve loading or voltage problems. Where their use is required, several other types may be available with the required voltage and kVA ratings.
 - (1) Chester area pad-mount transformer (see Table 4 on Page 5).
 - (2) Subsurface horizontal transformer (see Table 5 and Table 6 on Page 6).
 - (3) Subway-LB transformer (see Table 8 on Page 7).
 - B. Three-Phase: The standard transformer for three-phase service is Style MTP, Style IIE-LB, or Style IIG pad-mount transformer (see Table 12 through Table 19 on Pages 8 through 10). Where their use is required, several other types may be available with the required voltage and kVA ratings.
 - (1) Duplex-LB pad-mount transformer (see Table 9 on Page 7).
 - (2) Duplex subsurface transformers (see Table 21 on Page 10).
 - (3) Radial dead-front transformer (see Table 18 on Page 10).
 - (4) Style IIC transformer (see Table 20 on Page 10).
 - (5) Style IIH transformer (see Table 41 on Page 16).
 - (6) UCD-LB transformer (see Table 22 on Page 11).
 - C. "-LB" designation means that the transformer has the following characteristics:
 - (1) Uses bayonet fuses.
 - (2) Has backup current-limiting (CL) fuses.
 - (3) Has a load-break switch between bayonet and CL fuses.
 - (4) Will accommodate load-break elbows.
3. For replacement options of older style transformers, see [Document 068195](#) for recommendations.
4. See [Document 072149](#) for when to use pad-mount, subsurface, or vault-type transformers.
5. Each transformer code has been assigned a footnote indicating the desired use of the transformer as defined below:
 - A. "1 – Current Standard Design and May Be Purchased" - these are transformers with the most current type, size, and voltage rating and are regularly purchased and used.
 - B. "4 – Use for Replacement Only and May Be Purchased" - may be purchased as required for replacements. They should not be used for new construction.

- C. Transformers coded with an "E" are included in emergency stock.
 - D. Transformers coded as 1 are available for use on new business jobs.
 - E. Transformers coded as 4 are to be used only when required to replace an existing installation.
6. Transformers indicated as "stainless steel" have all exterior metal parts (unless otherwise noted in the referenced documents) fabricated out of stainless steel or other material of equal or superior corrosion resistance. These units shall be used whenever a transformer is to be installed in the severe or moderate corrosion areas of [Document 032911](#). Stainless steel units should also be used whenever local experience has determined that transformers experience accelerated corrosion leading to early replacement.

Application of Underground Distribution Transformers

Table of Contents

	Table/Figure	Page No.
Types Suitable for New Construction		
Single-Phase:		
• Pad-Mount Style DF-LB	Table 1 – Table 3	
• Pad-Mount Chester Area	Table 4	5
• Subsurface, Horizontal	Table 5 – Table 6	6
• Subsurface, Round	Table 7	6
• Subsurface, Subway-LB	Table 8	7
Three-Phase, Pad-Mount:		
• Duplex-DF	Table 9	7
• Style MTP	Table 10 – Table 11	7
• Style IIE-LB	Table 12 – Table 17	8–9
• Radial Dead-Front	Table 18	10
• Style IIG	Table 19	10
• Style IIC	Table 20	10
Three-Phase, Subsurface:		
• Duplex	Table 21	10
• UCD-LB	Table 22	11
Specialty Transformers		
Three-Phase, Subsurface :		
• Network	Table 23 – Table 25	11
Three-Phase, Dry Type:		
• Network	Table 26 – Table 27	12
Three-Phase, Pad-Mount:		
• Network	Table 28	12
• System Tie	Table 29 – Table 30	12
• Grounding Bank	Table 31	13
• Zigzag-Radial Dead-Front	Table 32	13
Types for Replacements Only		
Single-Phase:		
• Pad-Mount Live-Front, Clam Shell	Table 33 – Table 34	13–14
• Subsurface, Round	Table 35 – Table 37	14–15
Three-Phase, Pad-Mount:		
• Style IIC	Table 38	15
• Style IIF	Table 39 – Table 40	15–16
• Style IIH	Table 41	16
• Radial, Dead-Front	Table 42	16
• Radial, Live-Front	Table 43 – Table 44	17
Three-Phase, Subsurface Vault	Table 45	17
Transformer Winding Designations	Table 46 – Table 47	18–19
Transformer Insulating Fluid	Table 48	19
System Primary Voltages	Table 49	20
Pictorial Index	Figure 1 – Figure 6	21–26

References	Location	Document
Cabinet and Transformer for Single-Phase 12 kV Pad-Mounted Transformer Installation		
Underground Residential Areas	ELS	032732
Corrosion Area-Overhead Lines	OH: General/EPM	032911
Requirements for Conventional Three-Phase Small Power Transformers	ELS	033705
Single-Phase, Subsurface, Round Transformers	UG-1: Transformers	035313
Underground Commercial Distribution, Three-Phase, Subsurface Transformer	UG-1: Transformers	039830
Live-Front, Low-Profile, Single-Phase, Pad-Mounted Transformers	UG-1: Transformers	042761
Cabinet and Transformer for Low-Profile, Single-Phase, 6.9 kV Pad-Mounted Transformer Installation		
Underground Residential Systems	ELS	042764
Radial, Three-Phase, Pad-Mounted Transformers	UG-1: Transformers	043816
Loop-Style, Three-Phase, Pad-Mounted Transformers	UG-1: Transformers	045290
Pad-Mounted Network Transformer	UG-2: Transformers	045774
Open Wye to Zigzag Wye Transformation Equipment and Connection	UG-1: Transformers	045786
Three-Phase, Pad-Mounted Autotransformer	UG-1: Transformers/EPM	051119
Duplex-Type, Three-Phase, Subsurface Transformer	UG-1: Transformers	051776
Horizontal, Single-Phase, Subsurface Transformers	UG-1: Transformers	060578
Pad-Mounted Ground Fault Sensing for Cogeneration	UG-1: General	062264
Single-Phase, Dead-Front, and Duplex, Pad-Mounted Transformer	UG-1: Transformers	064307
4 kV Circuit Supply	UG-1: Transformers	068184
Distribution Transformer Replacement Options	UG-1: Transformers/EDM	068195
Three-Phase Subsurface Network Transformers	UG-2: Transformers	072137
Three-Phase Subsurface Vault Transformers	UG-2: Transformers	072138
Single-Phase Subway Transformers	UG-2: Transformers	072139
Pad-Mount Transformers-Style IIG and Style IIH	UG-1: Transformers	072146
Selection of the Type of Underground Equipment	UG-1: Transformers/Greenbook	072149
Engineering Material Specification #86, "Single-Phase, and Three-Phase Pad-Mounted Distribution Transformers"	TIL	EMS 86
Engineering Material Specification 91, "Single-Phase and Three-Phase Subsurface Distribution Transformers"	TIL	EMS 91

Single-Phase, Pad-Mount, for New Construction

Table 1 Codes for Style DF-LB, 1-Wire (2-Bushing) No Loop Switches With Transformer Switch With 2 Primary Bushings and 3 Secondary Bushings Including the Insulated Neutral (reference [Document 064307](#) and [Spec. 86](#)) – Self-Protected

kVA	20,780GRDY/12,000	
	240/120 V	
	Mild Steel	Stainless Steel
25	261501 ¹	262890 ¹
50	261502 ¹	262891 ¹
100	261503 ¹	262892 ¹
167	261504 ^{4, E}	262893 ^{4, E}

Table 2 Codes for Style DF-LB, 2-Wire, (4-Bushing) No Loop Switches With Transformer Switch With 4 Primary Bushings and 3 Secondary Bushings Including the Insulated Neutral (reference [Document 064307](#) and [Spec. 86](#)) – Self-Protected

kVA	12,000/20,780GrdY		17,200	20,780
	240/120 V		240/120 V	240/120 V
	Mild Steel	Stainless	Mild Steel	Mild Steel
25	261507 ¹	261519 ¹	261511 ¹	261515 ¹
50	261508 ¹	261520 ¹	261512 ¹	261516 ¹
100	261509 ¹	261521 ¹	261513 ¹	261517 ¹
167	261510 ⁴	261522 ^{4, E}	261514 ^{4, E}	261518 ^{4, E}

Table 3 Codes for Style DF-LB, 3-Wire, (6-Bushing) No Loop Switches With Transformer Switch and With 6 Primary Bushings and 3 Secondary Bushings Including the Insulated Neutral (reference [Document 064307](#) and [Spec. 86](#)) – Self-Protected

kVA	2,400/ 4,160GrdY	4,160 x 12,000		12,000/ 20,780GrdY		17,200	20,780		
	240/120 V	240/120 V		240/120 V		480/240 V	240/120 V	240/120 V	
	Mild Steel	Mild Steel	Stainless	Mild Steel	Stainless	Mild Steel	Mild Steel	Mild Steel	Stainless
25	–	–	–	261531 ¹	261543 ¹	262721 ^{1, E}	261535 ¹	261539 ¹	262894 ¹
50	–	–	–	261532 ¹	261544 ¹	–	261536 ¹	261540 ¹	262895 ¹
100	262043 ^{1, E}	261785 ¹	261988 ^{1, E}	261533 ¹	261545 ¹	–	261537 ¹	261541 ¹	262896 ¹
167	–	–	–	261534 ⁴	261546 ^{4, E}	–	261538 ^{4, E}	261542 ^{4, E}	262897 ^{4, E}

Table 4 Codes for Chester Style Specialty Transformers - Single-Phase, Pad-Mount, Load-Break, Dead-Front With Single-Phase Cabinet for Use in the Chester, CA Area. With 2 Primary Bushings and 3 Secondary Bushings Including the Insulated Neutral (see ANSI/IEEE Type 2(a) per IEEE C57.12.25) – Self-Protected

kVA	12,470GrdY/7,200 – 240/120 V	
	Mild Steel	
50	017414 ^{1, E}	
100	–	

¹ Current standard design and may be purchased.

⁴ Use for replacement only and may be purchased.

^E Included in Emergency Stock

Single-Phase, Subsurface, for New Construction

Table 5 Codes for Subsurface Horizontal, Single-Phase With 4 Primary Bushings With 2 (25-50 kVA) or 4 (75-167 kVA) Hot Secondary Leads. Neutral Lead May Be Permanently Grounded. (reference Document 060578 and Spec. 91) – Self-Protected, Stainless Steel

kVA	12,000/20,780GrdY 240/120 V		17,200 240/120 V	20,780 240/120 V	
	No Switch	With Single-Phase Switch	No Switch	No Switch	With Single-Phase Switch
25	262389 ¹	-	262395 ¹	262436 ¹	-
50	262391 ¹	-	262396 ¹	262437 ^{1, E}	-
100	262393 ^{1, E}	013884 ^{1, E}	262397 ¹	262438 ^{1, E}	262439 ^{1, E}
167	262394 ^{4, E}	262181 ^{4, E}	262398 ^{4, E}	263050 ^{4 E}	-

Table 6 Codes for Subsurface Horizontal, Single-Phase With 6 Primary Bushings With 2 (25-50 kVA) or 4 (75-167 kVA) Hot Secondary Leads. Neutral Lead May Be Permanently Grounded. (reference Document 060578 and Spec. 91) – Self-Protected, Stainless Steel

kVA	12,000/20,780GrdY 240/120 V		17,200 – 240/120 V		20,780 – 240/120 V	
	No Switch	With Three-Phase Switch	No Switch	With Three-Phase Switch	No Switch	With Three-Phase Switch
25	260328 ¹	027264 ^{1, E}	261106 ¹	-	261102 ¹	-
50	260668 ^{1, E}	-	261107 ^{1, E}	-	261103 ^{1, E}	-
100	260882 ^{1, E}	027266 ^{1, E}	261108 ¹	027269 ^{1, E}	261104 ^{1, E}	027267 ^{1, E}
167	261000 ^{4, E}	-	261109 ^{4, E}	-	261105 ^{4, E}	-

Table 7 Codes for Subsurface Round, Single-Phase With 3 Secondary Bushings, Neutral May be Permanently Grounded. Use to Supply Single-Phase Load. (reference Document 035313 and Spec. 91) – Self-Protected, Stainless Steel

kVA	4160/7200Y 240/120 V 4 Primary Bushings	4,160GrdY/2,400 240/120 V 2 Primary Bushings	
	No Switch	No Switch	With Single-Phase Switch
100	262371 ^{1, E}	262120 ^{1, E}	262143 ^{1, E}

(See Table 36 on Page 14 for other single-phase round transformers.)

¹ Current standard design and may be purchased.

⁴ Use for replacement only and may be purchased.
^E Included in Emergency Stock

Single-Phase, Subsurface, for New Construction (continued)

Table 8 Codes for Subsurface Subway-LB, Single-Phase, (reference [Document 072139](#) and [Spec. 91](#)) – Self-Protected, Stainless Steel

kVA	2,400/4,160Y-120/240 3 Primary Bushings 4 Secondary Bushings	12,000/20,780Y – 120/240	
		2 Primary Bushings 4 Secondary Bushings	3 Primary Bushings 4 Secondary Bushings
50	261388 ^{1, E}	261384 ¹	261391 ¹
100	261389 ¹	261385 ^{1, E}	261392 ^{1, E}
167	261390 ^{1, E}	261386 ¹	261393 ¹
250	–	261387 ^{1, E}	261394 ^{1, E}

Three-Phase, Pad-Mount, for New Construction

Table 9 Codes for Duplex-Style DF, Three-Phase, Pad-Mount, No Loop Switch, With Transformer Switch With 6 Primary Bushings and 4 Secondary Bushings Including the Insulated Neutral (reference [Document 064307](#) and [Spec. 86](#)) – Self-Protected

kVA	12,000/20,780GrdY/12,000		17,200	20,780
	240/120 V		240/120 V	240/120 V
	Mild Steel	Stainless	Mild Steel	Mild Steel
25/10	261547 ¹	–	261551 ¹	–
50/10	261548 ^{1, E}	262047 ^{1, E}	261552 ^{1, E}	261914 ^{1, E}
100/25	261549 ¹	–	261553 ¹	–
100/50	261550 ^{1, E}	262049 ^{1, E}	261554 ^{1, E}	261915 ^{1, E}

Table 10 Codes for Style MTP, Three-Phase, Pad-Mount With 6 Primary Bushings and 4 Secondary Bushings Including the Insulated Neutral (reference [Document 045290](#) and [Spec. 86](#)) – Self-Protected

kVA	12,000/20,780GrdY/12,000				20,780	
	208Y/120 V		480Y/277 V		208Y/120 V	480Y/277 V
	Mild Steel	Stainless	Mild Steel	Stainless	Mild Steel	
45	261897 ¹	261909 ¹	261898 ¹	261910 ¹	261905 ¹	261906 ¹
150	261899 ¹	261911 ^{1, E}	261900 ¹	261912 ^{1, E}	261907 ^{1, E}	261908 ^{1, E}

Table 11 Codes for Style MTP, Three-Phase, Pad-Mount With 6 Primary Bushings and 4 Secondary Bushings Including the Insulated Neutral (reference [Document 045290](#) and [Spec. 86](#)) – Self-Protected

kVA	4,160		17,200	
	208Y/120 V		480Y/277 V	
	Mild Steel		Mild Steel	
45	–	–	261901 ¹	261902 ¹
150	262782 ^{1, E}	262783 ^{1, E}	261903 ^{1, E}	261904 ^{1, E}

¹ Current standard design and may be purchased.

⁴ Use for replacement only and may be purchased.
^E Included in Emergency Stock

Three-Phase, Pad-Mount, for New Construction (continued)

Table 12 Codes for Style IIE-LB, No Loop Switches, With Transformer Switch With 6 Primary Bushings and 4 Secondary Bushings Including the Insulated Neutral (reference [Document 045290](#) and [Spec. 86](#)) – Self-Protected

kVA	4,160 x 12,000	
	208Y/120 V	480Y/277 V
	Mild Steel	Mild Steel
75	261397 ¹	261401 ¹
150	261398 ¹	261402 ¹
300	261399 ^{1, E}	261403 ^{1, E}
750	261400 ^{1, E}	261404 ^{1, E}

Table 13 Codes for Style IIE-LB, No Loop Switches, With Transformer Switch With 6 Primary Bushings and 4 Secondary Bushings Including the Insulated Neutral (reference [Document 045290](#) and [Spec. 86](#)) (continued) – Self-Protected

kVA	12,000/20,780GrdY/12,000						12,000/20,780Y12,000	
	208Y/120 V		480Y/277 V		2,400/4,160Y/2,400 V		240/120 Delta	
	Mild Steel	Stainless	Mild Steel	Stainless	Mild Steel	Stainless	Mild Steel	Stainless
75	261405 ¹	261443 ¹	261410 ¹	261446 ¹	–	–	–	–
150	261406 ¹	263128 ¹	261411 ¹	263124 ¹	–	–	261421 ¹	–
300	261407 ^{1, E}	261444 ^{1, E}	261412 ^{1, E}	261447 ^{1, E}	–	–	261422 ¹	262645 ^{1, E}
750	261408 ¹	263125 ¹	261413 ¹	263127 ¹	261417 ¹	–	–	–
1,000	261409 ^{1, E}	261445 ^{1, E}	261414 ^{1, E}	261448 ^{1, E}	261418 ¹	261450 ¹	–	–
1,500	–	–	261415 ¹	241619 ¹	261419 ¹	–	–	–
2,500	–	–	261416 ¹	261449 ^{1, E}	261420 ¹	261451 ^{1, E}	–	–

Table 14 Codes for Style IIE-LB, No Loop Switches, With Transformer Switch With 6 Primary Bushings and 4 Secondary Bushings Including the Insulated Neutral (reference [Document 045290](#) and [Spec. 86](#)) (continued) – Self-Protected

kVA	17,200		
	208Y/120 V	480Y/277 V	2,400/4,160Y/2,400 V
	Mild Steel	Mild Steel	Mild Steel
75	261423 ¹	261428 ¹	–
150	261424 ^{1, E}	261429 ^{1, E}	–
300	261425 ¹	261430 ¹	–
750	261426 ^{1, E}	261431 ^{1, E}	261435 ^{1, E}
1,000	261427 ^{1, E}	261432 ¹	–
1,500	–	261433 ^{1, E}	–
2,500	–	261434 ^{1, E}	261436 ^{1, E}

¹ Current standard design and may be purchased.

⁴ Use for replacement only and may be purchased.

^E Included in Emergency Stock

Application of Underground Distribution Transformers

Three-Phase, Pad-Mount, for New Construction (continued)

Table 15 Codes for Style IIE-LB, No Loop Switches, With Transformer Switch With 6 Primary Bushings and 4 Secondary Bushings Including the Insulated Neutral (reference [Document 045290](#) and [Spec. 86](#)) (continued) – Self-Protected

kVA	20,780			
	208Y/120 V		480Y/277 V	
	Mild Steel	Stainless	Mild Steel	Stainless
75	261437 ¹	261452 ¹	261440 ¹	261454 ¹
150	261438 ¹	–	261441 ¹	–
300	261439 ¹	261453 ^{1, E}	261442 ¹	261455 ^{1, E}

Table 16 Codes for Style IIE-LB, With Three-Phase Loop Switches, With Transformer Switch With 6 Primary Bushings and 4 Secondary Bushings Including the Insulated Neutral (reference [Document 045290](#) and [Spec. 86](#)) – Self-Protected

kVA	12,000/20,780GrdY/12,000			
	208Y/120 V		480Y/277 V	
	Mild Steel	Stainless	Mild Steel	Stainless
75	261456 ¹	–	261459 ¹	–
300	261457 ^{1, E}	–	261460 ^{1, E}	–
1,000	261458 ¹	261472 ^{1, E}	261461 ¹	261473 ^{1, E}
1,500	–	–	261893 ¹	–
2,500	–	–	261894 ¹	261895 ^{1, E}

Table 17 Codes for Style IIE-LB, With Three-Phase Loop Switches, With Transformer Switch With 6 Primary Bushings and 4 Secondary Bushings Including the Insulated Neutral (reference [Document 045290](#) and [Spec. 86](#)) (continued) – Self-Protected

kVA	17,200		20,780	
	208Y/120 V	480Y/277 V	208Y/120 V	480Y/277 V
	Mild Steel	Mild Steel	Mild Steel	Mild Steel
75	261462 ¹	261465 ¹	261468 ¹	261470 ¹
300	261463 ^{1, E}	261466 ^{1, E}	261469 ^{1, E}	261471 ^{1, E}
1,000	261464 ^{1, E}	261467 ^{1, E}	–	–
2,500	–	261896 ^{1, E}	–	–

¹ Current standard design and may be purchased.

⁴ Use for replacement only and may be purchased.

^E Included in Emergency Stock

Three-Phase, Pad-Mount, for New Construction (continued)

Table 18 Codes for Radial Dead-Front, Three-Phase, Pad-Mount With 3 Primary Bushings and 4 Secondary Bushings Including the Insulated Neutral (reference [Document 043816](#) and [Spec. 86](#)) – Conventional

kVA	20,780			
	208Y/120 V		480Y/277 V	
	Mild Steel	Stainless	Mild Steel	Stainless
750	-	-	263031 ^{1, E}	-
1,000	263029 ¹	261523 ^{1, E}	-	261524 ¹
1,500	-	-	263033 ¹	-
2,500	-	-	263035 ¹	261525 ^{1, E}

(See Table 42 on Page 16 for other three-phase radial DF.)

Table 19 Codes for Style IIG, Three-Phase, Pad-Mount With Vacuum Fault Interrupter, With 6 Primary Bushings, 4 Secondary Bushings Including Insulated Neutral With Stainless Steel Cabinet and FR3 Insulating Fluid (reference [Document 072146](#) and [Spec. 86](#))

kVA	12,000/20,780Grd/12,000		12,000/20,780Grd/12,000	17,200		20,780
	480Y/277		2,400/4160Y/2,400	480Y/277	2,400/4160Y/2,400	480Y/277
kVA	No Loop Switch	With 2 Loop Switches	No Switch	No Loop Switch		
2955/3325	262702 ^{1, E}	262703 ^{1, E}	262704 ^{1, E}	262705 ^{1, E}	262706 ^{1, E}	262707 ^{1, E}

Table 20 Codes for Style IIC, Three-Phase, Pad-Mount With 3 Primary Bushings and 4 Secondary Bushings Including the Insulated Neutral (reference [Document 045290](#) and [Spec. 86](#)) – Self-Protected

kVA	4,160 x 12,000	
	208Y/120 V	480Y/277 V
	Mild Steel	Mild Steel
1,500	-	260789 ¹
2,500	-	260791 ^{1, E}

(See Table 38 on Page 15 for other Style IIC.)

Three-Phase, Subsurface, for New Construction

Table 21 Codes for Subsurface Duplex, Three-Phase With 6 Primary Bushings and 3 Hot Secondary Leads or Insulated Spades. The Neutral is a Welded Spade. (reference [Document 051776](#) and [Spec. 91](#)) – Self-Protected, Stainless Steel

kVA	12,000/20,780GrdY/12,000 – 240/120 V		17,200 – 240/120 V	
	No Switch	With Three-Phase Switch	No Switch	With Three-Phase Switch
25/10	262122 ¹	262131 ¹	262349 ¹	262348 ¹
50/10	262128 ^{1, E}	262132 ^{1, E}	262350 ^{1, E}	262354 ¹
75/15	-	262133 ¹	-	262355 ¹
100/25	262130 ¹	262134 ¹	262352 ¹	262356 ^{1, E}
100/50	262363 ^{1, E}	262318 ^{1, E}	262353 ^{1, E}	262357 ^{1, E}

¹ Current standard design and may be purchased.

⁴ Use for replacement only and may be purchased.

^E Included in Emergency Stock

Application of Underground Distribution Transformers

Three-Phase, Subsurface, for New Construction (continued)

Table 22 Codes for Subsurface UCD-LB, Three-Phase With Two, Three-Phase Loop Switches and With Transformer Switches With 6 Primary Bushings and 3 Hot Secondary Bushings. The Neutral May Be Permanently Grounded. (reference [Document 039830](#) and [Spec. 91](#)) – Self-Protected, Stainless Steel

kVA	4,160 x 12,000		12,000/20,780GrdY/12,000		17,200	
	208Y/120 V	480Y/277	208Y/120	480Y/277	208Y/120	480Y/277
150	261798 ¹	261800 ¹	261802 ¹	261806 ¹	261810 ¹	261813 ¹
300	261799 ^{1, E}	261801 ^{1, E}	261803 ^{1, E}	261807 ^{1, E}	261811 ¹	261814 ¹
750	262327 ^{1, E}	262332 ^{1, E}	261804 ¹	261808 ¹	261812 ^{1, E}	261815 ^{1, E}
1,000	–	–	261805 ^{1, E}	261809 ^{1, E}	–	–

Specialty Transformers

Table 23 Codes for Subsurface Network, Three-Phase With 3 Primary Bushings and 3 Secondary Bushings With No Ground Switch, No Termination Chamber (reference [Document 072137](#) and [Spec. 91](#)) – Conventional, Plate Steel

kVA	12,000 – 208Y/120 V	12,000 – 480Y/277 V	12,000X34,500GrdY/19920 480Y/277 V	34,500GrdY/19,920 480Y/277 V
300	262664 ¹	–	–	–
500	262665 ¹	–	–	–
750	262666 ¹	262667 ^{1, T}	262673 ¹	262671 ¹
1,000	–	262668 ^{1, T}	262674 ¹	262662 ¹
1,500	–	262669 ^{1, T}	262675 ¹	262672 ¹
2,000	–	262670 ^{1, T}	262676 ¹	262663 ¹

Table 24 Codes for Subsurface Network, Three-Phase With 3 Primary Bushings and 3 Secondary Bushings With Ground Switch and Termination Chamber (reference [Document 072137](#) and [Spec. 91](#)) – Conventional, Plate Steel

kVA	12,000 – 208Y/120 V	12,000 – 480Y/277 V	12,000X34,500GrdY/19920 480Y/277 V	34,500GrdY/19,920 480Y/277 V
300	262407 ⁴	–	–	–
500	262408 ⁴	262410 ^{4, T}	–	–
750	262409 ^{4, E}	262411 ^{4, T}	262419 ⁴	262415 ⁴
1,000	–	262412 ^{4, E, T}	262420 ⁴	262416 ⁴
1,500	–	262413 ^{4, T}	262421 ⁴	262417 ⁴
2,000	–	262414 ^{4, T}	262422 ^{4, E}	262418 ⁴

Table 25 Codes for Subsurface Vault, Three-Phase with 3 Primary Bushings and 3 Secondary 600A ESNA Bushings ([Spec. 91](#)).

kVA	12,000 x 34,500GrdY/19,920 – 4,160Y/2400 V
2,000	262889 ¹

¹ Current standard design and may be purchased.

⁴ Use for replacement only and may be purchased.

E Included in Emergency Stock

T With high voltage taps.

Specialty Transformers (continued)

Table 26 Codes for Dry-Type Network. Three-Phase With 3 Primary Bushings and 3 Secondary Bushings – Conventional, 65/115° Rise Cast Coil, Rotated Layout

kVA	12,000 – 208Y/120 V	12,000 – 480Y/277 V	34,500GrdY/19,920 480Y/277 V
500	262777 ^{1, T}	–	–
750	262778 ^{1, T}	262773 ^{1, T}	262779 ^{1, T}
1,000	–	262774 ^{1, T}	262780 ^{1, T}
1,500	–	262775 ^{1, T}	–
2,000	–	262776 ^{1, T}	262781 ^{1, T}

Table 27 Codes for Dry-Type Network. Three-Phase With 3 Primary Bushings and 3 Secondary Bushings – Conventional, 65/115° Rise Cast Coil, In-Line Layout

kVA	12,000 – 208Y/120 V	12,000 – 480Y/277 V	34,500GrdY/19,920 480Y/277 V
500	–	–	–
750	–	–	262816 ^{1, T}
1,000	–	262813 ^{1, T}	262817 ^{1, T}
1,500	–	262814 ^{1, T}	–
2,000	–	262815 ^{1, T}	262818 ^{1, T}

Table 28 Codes for Pad-Mount Network, Three-Phase With 3 Primary Bushings and 3 Secondary Bushings (reference [Document 045774](#) and [Spec. 86](#)) – Conventional, Mild Steel

kVA	12,000 - 480Y/277 V	34,500GrdY/19,920 - 480Y/277 V
750	260666 ¹	260655 ¹
1,000	260667 ¹	260656 ¹
1,500	260684 ¹	260657 ¹
2,000	260699 ¹	260658 ¹

¹ Current standard design and may be purchased.

⁴ Use for replacement only and may be purchased.

E Included in Emergency Stock

T With high voltage taps

Specialty Transformers (continued)

Table 29 Codes for System Tie, Three-Phase, Pad-Mount With 3 Primary Bushings and 3 Secondary Bushings (reference [Document 068184](#) and [Spec. 86](#)) – Conventional, Mild Steel

kVA	12,000/20,780GrdY/12,000 - 4,160GrdY/2,400 V 0° Phase Shift @ 21 kV 30° Phase Shift @ 12 kV	12,000 -4,800	6,930/12,000Y - 4,160Y/2,400 V 0° Phase Shift @ 12 kV	20780 - 4,160GrdY/2,400 V 30° Phase Shift @ 21 kV
	With One Recloser on Secondary Side			
2,500	261381 ^{1, E}	-	262578 ^{1, E}	262579 ^{1, E}
3,000	-	262696 ^{1, E}	-	

Table 30 Codes for System Tie, Three-Phase, Pad-Mount With 3 Primary Bushings and 3 Secondary Bushings (reference [Document 051119](#) and [Spec. 86](#)) (continued) – Conventional, Mild Steel

kVA	20,780Y/12,000		17,200 V Delta	
	12,000Y/6,930 V		12,000Y/6930 V	
	Without Recloser	With 2 Reclosers	30° Lead to 30° Lag Switch With Recloser on 21 kV Side	30° Lead to 30° Lag Switch Without Recloser
3,600	264134 ¹	262661 ^{1, E}		261151 ^{1, E, T}
7,500	261943 ¹	262473 ^{1, E}	262573 ^{1, E, T}	

Table 31 Codes for Pad-Mount, Grounding Bank, Three-Phase, (for cogeneration fault sensing with Ho bushing, 2.5% impedance) With 6 Primary Bushings and 3 Secondary Bushings (reference [Document 062264](#) and [Spec. 86](#)) – Self-Protected, Mild Steel

kVA	20,780GrdY/12,000 - 480 V Delta
225	017072 ¹

Table 32 Codes for Zigzag - Radial Dead-Front, Three-Phase, Pad-Mount With 2 Primary Bushings and 4 Secondary Bushings Including the Insulated Neutral (reference [Document 045786](#) and [Spec. 86](#)) – Conventional, Mild Steel

kVA	20,780GrdY/12,000	
	208Y/120 V	480Y/277 V
300	263073 ^{1, E}	263076 ^{1, E}

Single-Phase, Pad Mount, for Replacements Only

Table 33 Codes for Live-Front, Clam Shell, Single-Phase, Pad-Mount With 2 Primary Bushings and 2 Hot Secondary Bushings. Neutral May Be Permanently Grounded. (reference [Document 042761](#) and [Spec. 86](#)) – Self-Protected

kVA	With Single-Phase Cabinet		
	12,000GrdY/6,930 - 240/120 V	12,000/20,780 GrdY - 240/120 V	
	Mild Steel	Mild Steel	Stainless Steel
50	-	263002 ⁴	263037 ⁴
100	261274 ^{4, E}	263004 ^{4, E}	263038 ^{4, E}
167	261275 ^{4, E}	263016 ^{4, E}	263039 ⁴

¹ Current standard design and may be purchased.

⁴ Use for replacement only and may be purchased.
^E Included in Emergency Stock
^T With high voltage taps

Single-Phase, Pad Mount, for Replacements Only (continued)

Table 34 Codes for Live-Front, Clam Shell, Single-Phase, Pad-Mount With 3 Primary Bushings and 2 Hot Secondary Bushings. Neutral May Be Permanently Grounded. (reference [Document 042761](#) and [Spec. 86](#)) (continued) – Self-Protected

kVA	With Three-Phase Cabinet					
	12,000GrdY/6,930 240/120	4,160X12,000 240/120 V	12,000/20,780 GrdY – 240/120 V		17,200 240/120 V	20,780 240/120 V
	Mild Steel	Mild Steel	Mild Steel	Stainless Steel	Mild Steel	Mild Steel
50	–	263014 ^{4, E}	263006 ^{4, E}	263040 ^{4, E}	263010 ^{4, E}	263044 ⁴
100	261276 ^{4, E}	263015 ^{4, E}	263008 ^{4, E}	263041 ^{4, E}	263012 ^{4, E}	263045 ^{4, E}
167	261277 ^{4, E}	263019 ^{4, E}	263017 ^{4, E}	263042 ⁴	263018 ^{4, E}	263046 ^{4, E}

Single-Phase, Subsurface Round, for Replacements Only

Table 35 Codes for Subsurface Round, Single-Phase, 3 Secondary Bushings With Insulated Neutral. Use as the Power Transformer in the Bank. (reference [Document 035313](#) and [Spec. 91](#)) – Self-Protected, Stainless Steel

kVA	4,160/7,200Y – 240/120 V 4 Primary Bushings		4,160GrdY/2,400 – 240/120 V 2 Primary Bushings		12,000/20,780GrdY 240/120 V 4 Primary Bushings	17,200 – 240/120 V 4 Primary Bushings
	No Switch	With Single-Phase Switch	No Switch	With Single-Phase Switch	No Switch	No Switch
25	262362 ^{4 E}	262316 ⁴	–	–	–	–
50	–	–	–	–	–	262314 ⁴
75	–	–	262328 ⁴	–	–	–
100	–	–	–	–	262283 ^{4, E}	–
167	–	–	–	–	262284 ^{4, E}	–

Table 36 Codes for Subsurface Round Single-Phase With 3 Secondary Bushings, Neutral May Be Permanently Grounded. Use to Supply Single-Phase Load or as the Lighting Transformer in a Bank. (reference [Document 035313](#) and [Spec. 91](#)) – Self-Protected, Stainless Steel

kVA	4,160/7,200Y 240/120 V 4 Primary Bushings	4,160GrdY/2,400 240/120 V 2 Primary Bushings		12,000/20,780GrdY 240/120 V 4 Primary Bushings		12,000/20,780GrdY 480/240 V 4 Primary Bushings
	No Switch	No Switch	With Single-Phase Switch	No Switch	With Single-Phase Switch	No Switch
25	–	–	–	–	–	262307 ^{1, E}
50	–	–	–	262058 ^{4, E}	262096 ^{4, E}	–
75	–	–	–	–	–	262324 ^{4, E}
100	(see Table 7 on Page 6)			262060 ^{4, E}	262098 ^{4, E}	–
167	262372 ^{4, E}	262121 ^{4, E}	262144 ⁴	262062 ^{4, E}	262099 ^{4, E}	–

¹ Current standard design and may be purchased.

⁴ Use for replacement only and may be purchased.
^E Included in Emergency Stock

Single-Phase, Subsurface Round, for Replacements Only (continued)

Table 37 Codes for Subsurface Round, Single-Phase With 3 Secondary Bushings, Neutral May Be Permanently Grounded. Use to Supply Single-Phase Load or as the Lighting Transformer in a Bank. (reference [Document 035313](#) and [Spec. 91](#)) (continued) – Self-Protected, Stainless Steel

kVA	12,000GrdY/6,930 240/120 V 2 Primary Bushings		17,200 240/120 V 4 Primary Bushings		20,780GrdY/12,000 240/120 V 2 Primary Bushings		20,780GrdY/12,000 480/240 V 2 Primary Bushings	
	No Switch	With Single-Phase Switch	No Switch	No Switch	No Switch	With Single-Phase Switch	No Switch	With Single-Phase Switch
25	-	-	-	-	-	-	262321 ^{1, E}	262303 ^{1, E}
50	262054 ^{4, E}	262090 ^{4, E}	262186 ^{4, E}	262147 ^{4, E}	262153 ^{4, E}	-	-	-
100	262056 ^{4, E}	262092 ^{4, E}	262188 ^{4, E}	262149 ^{4, E}	262155 ^{4, E}	-	-	-
167	262086 ^{4, E}	262093 ^{4, E}	262189 ^{4, E}	262150 ^{4, E}	262156 ^{4, E}	-	-	-

Three-Phase, Pad-Mount, for Replacements Only

Table 38 Codes for Style IIC*, Three-Phase, Pad-Mount With 3 Primary Bushings and 4 Secondary Bushings Including the Insulated Neutral (reference [Document 045290](#) and [Spec. 86](#)) – Self-Protected

kVA	4,160X12,000	
	480Y/277 V	
	Mild Steel	
1,500	260789 ¹	
2,500	260791 ^{1, E}	

(Style IIC and Style IIF transformers are completely interchangeable except for the primary fuses.)

*See Table 20 on Page 10 for others of this type.

Table 39 Codes for Style IIF, Three-Phase, Pad-Mount With 3 Primary Bushings and 4 Secondary Bushings Including the Insulated Neutral (reference [Document 045290](#) and [Spec. 86](#)) – Self-Protected

kVA	12,000/20,780GrdY/12,000					
	208Y/120		480Y/277		2,400/ 4,160Y/2,400	
	Mild Steel	Stainless Steel	Mild Steel	Stainless Steel	Mild Steel	Stainless Steel
300	261284 ^{4, E}	-	261288 ⁴	262115 ^{4, E}	-	-
750	261285 ⁴	-	261289 ⁴	-	-	-
1,000	261286 ^{4, E}	262114 ⁴	261290 ⁴	262116 ^{4, E}	261292 ⁴	-
1,500	-	-	261291 ⁴	-	261293 ⁴	-
2,500	-	-	261328 ⁴	262177 ^{4, E}	261329 ⁴	262179 ^{4, E}

¹ Current standard design and may be purchased.

⁴ Use for replacement only and may be purchased.
^E Included in Emergency Stock

Three-Phase, Pad-Mount, for Replacements Only (continued)

Table 40 Codes for Style IIF, Three-Phase, Pad-Mount With 3 Primary Bushings and 4 Secondary Bushings Including the Insulated Neutral (reference [Document 045290](#) and [Spec. 86](#)) (continued) – Self-Protected

kVA	4,160X12,000		17,200	
	208Y/120	480Y/277	208Y/120	480Y/277
	Mild Steel	Mild Steel	Mild Steel	Mild Steel
300	261281 ⁴	261283 ⁴	–	261296 ⁴
750	261287 ^{4, E}	261282 ^{4, E}	261294 ⁴	261297 ⁴
1,000	–	–	261295 ^{4, E}	261298 ^{4, E}
1,500	–	–	–	261299 ⁴
2,500	–	–	–	261330 ^{4, E}

Table 41 Codes for Style IIH, Three-Phase, Pad-Mount, Live-Front With Vacuum Fault Interrupter, with 3 Primary Bushings and 4 Secondary Bushings With Insulated Neutral With Stainless Steel Cabinet and FR3 Insulating Fluid (reference [Document 072146](#) and [Spec. 86](#))

kVA	12,000/20,780GrdY/12,000		17,200
	480Y/277	2,400/4160Y/2,400	480Y/277
	Mild Steel	Mild Steel	Mild Steel
2955/3325	262708 ^{4, E}	262709 ^{4, E}	262710 ^{4, E}

Table 42 Codes for Radial, Dead-Front*, Three-Phase, Pad-Mount With 3 Primary Bushings and 4 Secondary Bushings Including the Insulated Neutral (reference [Document 043816](#) and [Spec. 86](#)) (continued) – Conventional

kVA	12,000/20,780GrdY/12,000		17,200
	208Y/120 V	480Y/277 V	480Y/277 V
	Mild Steel	Mild Steel	Mild Steel
75	260315 ⁴	260314 ⁴	–
150	260732 ⁴	260317 ⁴	–
300	260682 ⁴	260326 ⁴	–
750	260080 ^{4, E}	260039 ^{4, E}	260880 ^{4, E}
1,000	260107 ^{4, E}	260041 ⁴	260181 ⁴
1,500	–	260002 ⁴	260883 ^{4, E}
2,500	–	260042 ^{4, E}	–

* See Table 18 on Page 10 for others of this type.

¹ Current standard design and may be purchased.

⁴ Use for replacement only and may be purchased.

^E Included in Emergency Stock

Application of Underground Distribution Transformers

Three-Phase, Pad-Mount, for Replacements Only (continued)

Table 43 Codes for Radial, Live-Front, Three-Phase, Pad-Mount With 3 Primary Bushings and 4 Secondary Bushings Including the Insulated Neutral (reference [Document 043816](#) and [Spec. 86](#)) – Conventional

kVA	4,160X12,000		17,200	
	208Y/120 V	480Y/277 V	208Y/120 V	480Y/277 V
	Mild Steel	Mild Steel	Mild Steel	Mild Steel
75	260695 ⁴	–	260309 ⁴	260613 ⁴
150	–	–	–	260615 ⁴
300	–	–	260289 ⁴	260617 ⁴
750	260921 ⁴	–	–	–

Table 44 Codes for Radial, Live-Front, Three-Phase, Pad-Mount With 3 Primary Bushings and 4 Secondary Bushings Including the Insulated Neutral (reference [Document 043816](#) and [Spec. 86](#)) (continued) – Conventional

kVA	12,000/20,780GrdY/12,000	
	208Y/120 V	480Y/277 V
	Mild Steel	Mild Steel
75	260710 ⁴	260764 ⁴
150	260755 ⁴	260766 ⁴
300	260757 ⁴	260768 ⁴
750	260759 ⁴	260770 ^{4, E}
1,000	260760 ^{4, E}	–
1,500	–	260677 ⁴
2,500	–	260773 ^{4, E}

Table 45 Codes for Subsurface Vault, Three-Phase With 3 Primary Bushings and 4 Secondary Bushings Including the Insulated Neutral (reference [Document 072138](#) and [Spec. 91](#)) – Conventional, Plate Steel

kVA	12,000/20,780GrdY/12,000 – 208Y/120 V	12,000/20,780GrdY/12,000 – 480Y/277 V
300	262428 ⁴	–
750	262430 ⁴	262432 ⁴
1,000	262107 ^{4, E}	262433 ^{4, E}
1,500	–	262434 ⁴
2,500	–	015641 ^{4, E}





¹ Current standard design and may be purchased.

⁴ Use for replacement only and may be purchased.

^E Included in Emergency Stock

Designation of Voltage Ratings of Windings - Single-Phase Transformers

Table 46 Designation of Voltage Ratings of Windings – Single-Phase Transformers

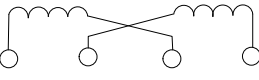
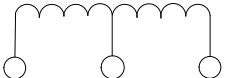
Item	Designation	Typical Voltage Rating	Typical Winding Diagram	Description
1	E	12,000		Indicates a winding of E volts which is suitable for delta connection on an E volt system.
2	E/E ₁ Y ¹	2,400/4,160Y		Indicates a winding of E volts which is suitable for delta connection on an E volt system or for wye connection on an E ₁ volt system.
3	E/E ₁ Grd.Y ¹	12,000/20,780 Grd. Y or 2,400/4,160 Grd. Y		Indicates a winding of E volts having insulation suitable for delta connection on an E volt system or for wye connection on an E ₁ volt effectively grounded system.
4	E ₁ Grd.Y/E ¹	20,780 Grd. Y/12,000 or 12,000 Grd. Y/6,930		Indicates a winding of E volts which has one end of the winding grounded internally. Windings with one end grounded internally are suitable for single-phase or wye operation on a three-phase E ₁ volt effectively grounded system.
5	E/2E	120/240 or 240/480		Indicates a winding, the sections of which can be connected in parallel for operation at E volts, connected in series for operation at 2E volts, or connected in series with a center terminal for 3-wire operation at 2E volts between the extreme terminals and E volts between the center terminal and each of the extreme terminals.
6	2E/E	240/120		Indicates a winding having a mid-tap and suitable for 3-wire operation at 2E volts between extreme terminals and at E volts between the mid-tap and each of the extreme terminals (not reconnectable).

¹ E₁ = $\sqrt{3}$ E

Application of Underground Distribution Transformers

Designation of Voltage Ratings of Windings - Three-Phase Transformers

Table 47 Designation of Voltage Ratings of Windings - Three-Phase Transformers

Item	Designation	Typical Voltage Rating	Typical Winding Diagram	Description
7	E	12,000		Indicates a winding that is permanently delta connected for operation on an E volt system.
8	E ₁ Grd.Y/E ¹	20,780 Grd.Y/12,000 or 34,500 Grd.Y/19,920		Indicates a winding that is permanently wye connected with neutral grounded to the tank for operation on an E ₁ volt effectively grounded system with E volts available from line to neutral.
9	E/E ₁ Grd.Y/E ¹	12,000/20,780 Grd.Y/12,000		Indicates a winding which may be delta connected for operation on an E volt system or may be wye connected for operation on an E ₁ volt grounded system with E volts available from line to neutral.
10	V x V ₁	4,160 x 12,000		Indicates a permanently delta connected winding for multiple or series operation.
11		12,000 x 34,500 Grd. Y/19,920		Indicates a winding which may be delta connected for operation on a 12 kV system or wye connected for operation on a 34.5 kV effectively grounded wye system.

¹ E₁ = $\sqrt{3} E$

Table 48 Transformer Insulating Fluid Material Codes

	FR3 High-Fire Point Natural Ester	BioTemp High-Fire Point Natural Ester	Mineral Oil	Silicone High-Fire Point
National Standard	ASTM D6871	ASTM D6871	ASTM D3487	ASTM D4652
5 Gallon Pail			M507033	
55 Gallon Drum	M500046		M507034	M500043
Bulk			M507017	

Primary Voltages

Table 49 System Primary Voltages ¹

Phase	Primary Voltages	System
Single-Phase	2,400/4,160Y	For 2.4 kV - L-L Connection
Single-Phase	2,400 x 4,800	For 2.4 kV - L-L Connection
Single-Phase	4,160/7,200Y	For 4 kV - L-L Connection
Single-Phase	4,160GrdY/2,400	For 4 kV - 4-Wire L-G Connection
Single-Phase	4,160 x 12,000	For 4 kV - L-L Connection
Single-Phase	4,160 x 7,200	For 4 kV - L-L Connection
Single-Phase	7,200/12,470Y	For 12 kV - 4-Wire L-G Connection
Single-Phase	12,000	For 12 kV L-L or 21 kV L-G Connection
Single-Phase	12,000/20,780 GrdY	For 12 kV L-L or 21 kV L-G Connection
Single-Phase	12,000/20,780Y	For 12 kV L-L or 21 kV L-G Connection
Single-Phase	12,000GrdY/6,930	For 12 kV - 4-Wire L-G Connection
Single-Phase	12,470GrdY/7,200	For Use in Chester
Single-Phase	17,200	For 17 kV L-L Connection
Single-Phase	20,780	For 21 kV L-L Connection
Single-Phase	20,780GrdY/12,000	For 21 kV - 4-Wire L-G Connection
Single-Phase	24,940GrdY/14,400	For Use in Chester
Single-Phase	44,000	For 44 kV - L-L Connection
Single-Phase	44,000/25,400	For 44 kV - L-L Connection
Three-Phase	4,160	For 4 kV - Delta Connection
Three-Phase	4,160GrdY/2,400	For 4 kV - 4-Wire L-G Connection
Three-Phase	4,160 x 12,000	For 4 kV - Delta Connection
Three-Phase	4,160 x 12,480	For 4 kV - Delta Connection
Three-Phase	12,000	For 12 kV - Delta Connection
Three-Phase	12,000/20,780GrdY/12,000	For 12 kV Delta or 21 kV GrdY Connection
Three-Phase	12,000 x 20,780	For 12 kV Delta or 21 kV Delta Connection
Three-Phase	12,000 x 34,500GrdY/19,920	For 12 kV or 34.5 kV Networks
Three-Phase	17,200	For 17 kV Delta Connection
Three-Phase	20,780	For 21 kV Delta Connection
Three-Phase	20,780GrdY/12,000	For 21 kV GrdY Connection
Three-Phase	20,780Y/12,000	For 21 kV Y Connection
Three-Phase	34,500GrdY/19,920	For 34.5 kV Networks

¹ Table 49 is intended to be a reference between the transformer's primary voltage and the type of primary system that it can be used on in the PG&E system.

Pictorial Index

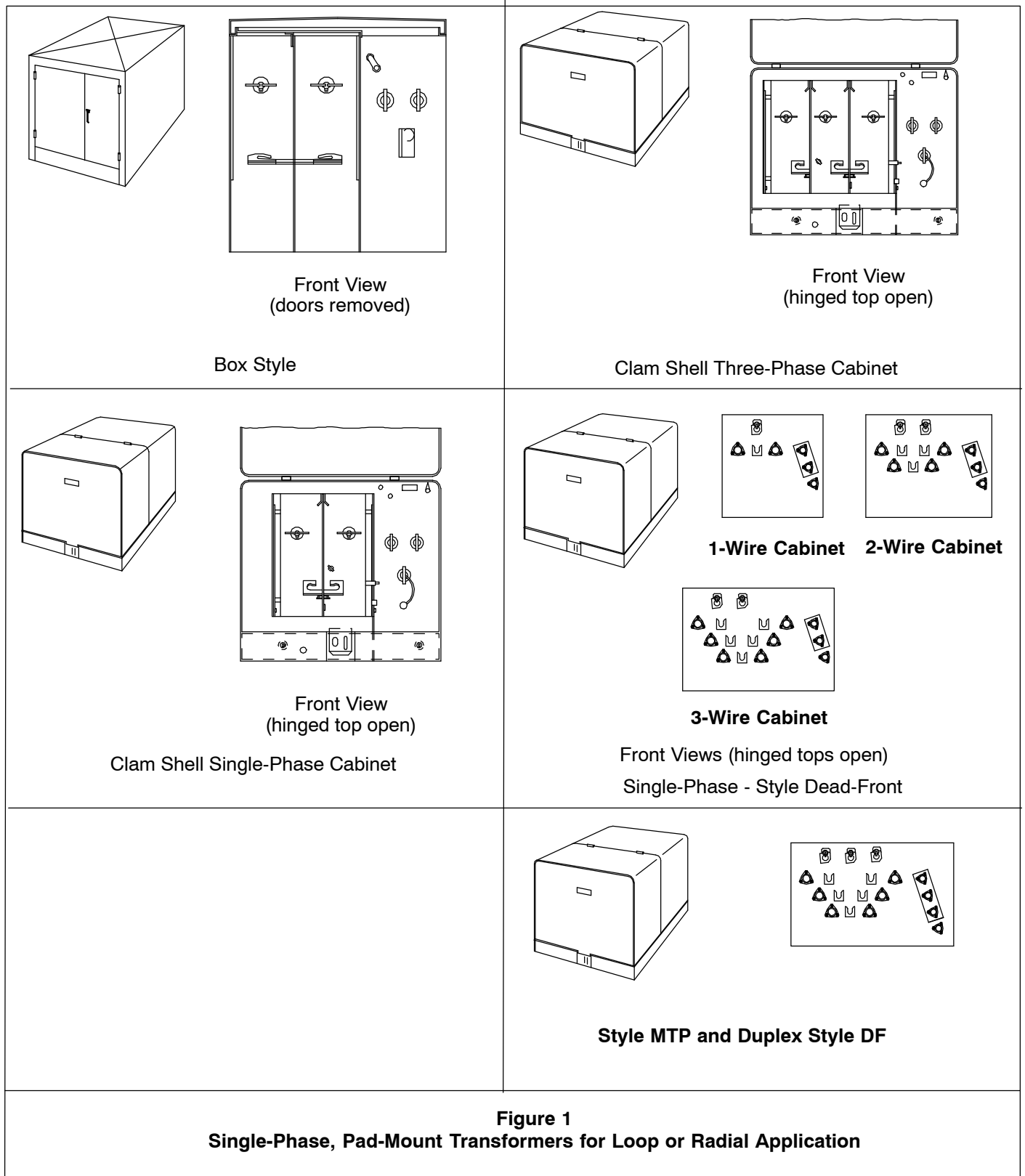

Pictorial Index (continued)

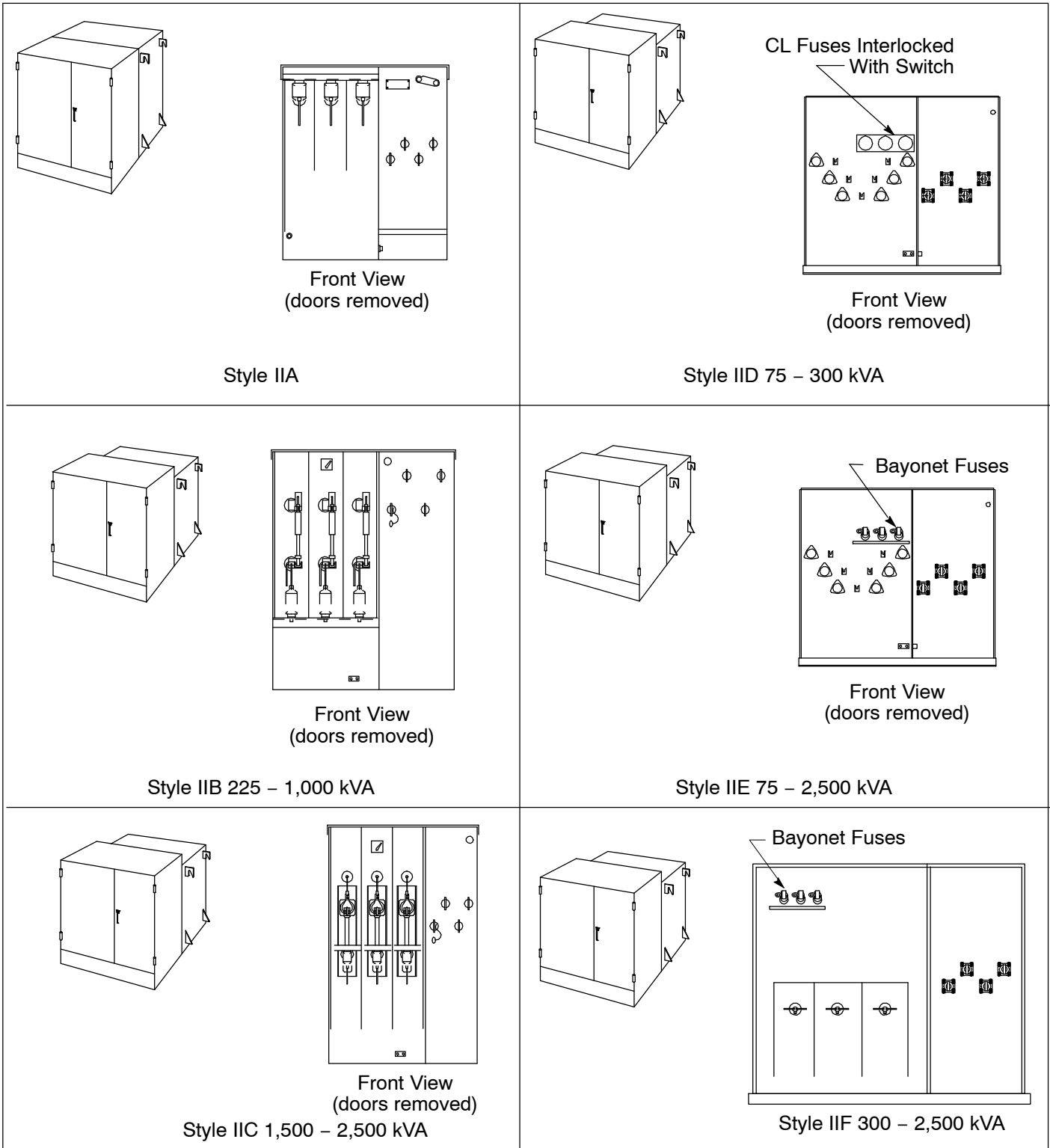

Figure 2
Three-Phase, Pad-Mount Transformers for Loop or Radial Application

Application of Underground Distribution Transformers

Pictorial Index (continued)

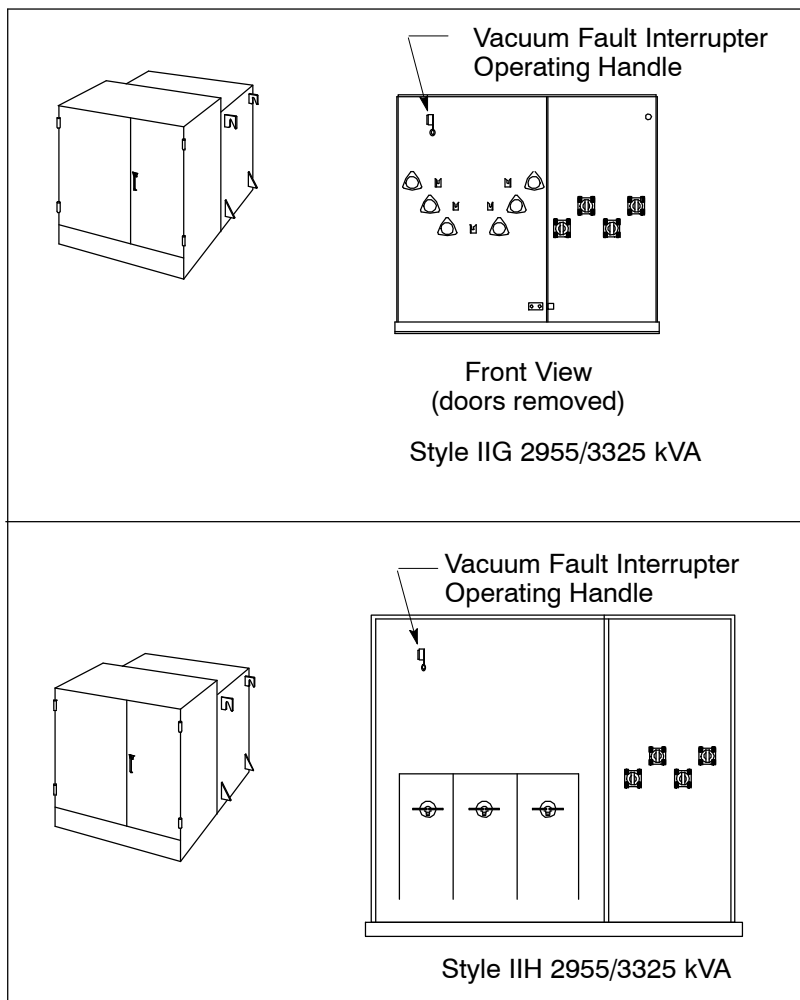

Figure 3
Three-Phase, Pad-Mount Transformers for Loop or Radial Application

Pictorial Index (continued)

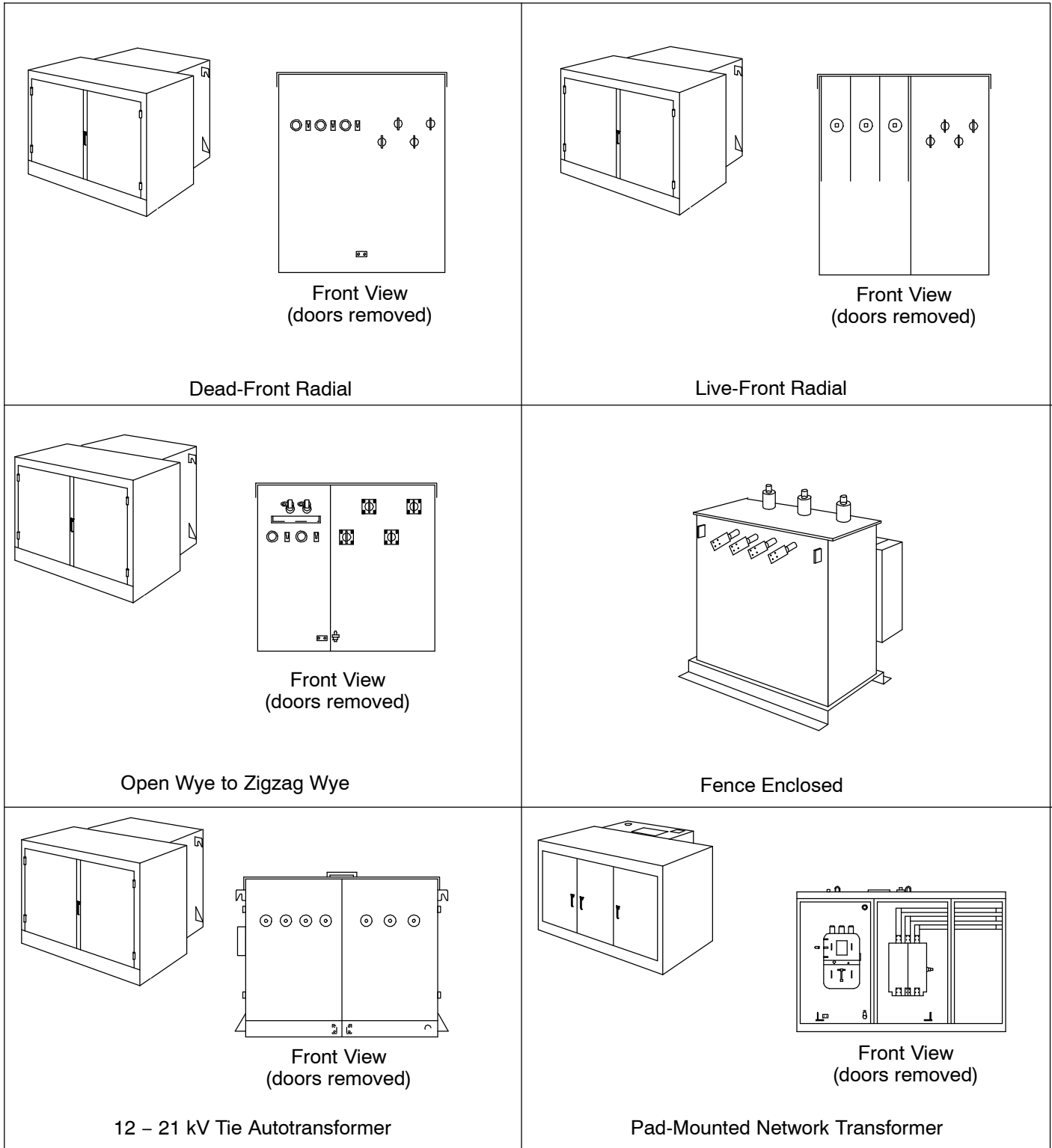

Figure 4
Three-Phase, Pad-Mount Transformers for Radial Application

Application of Underground Distribution Transformers

Pictorial Index (continued)

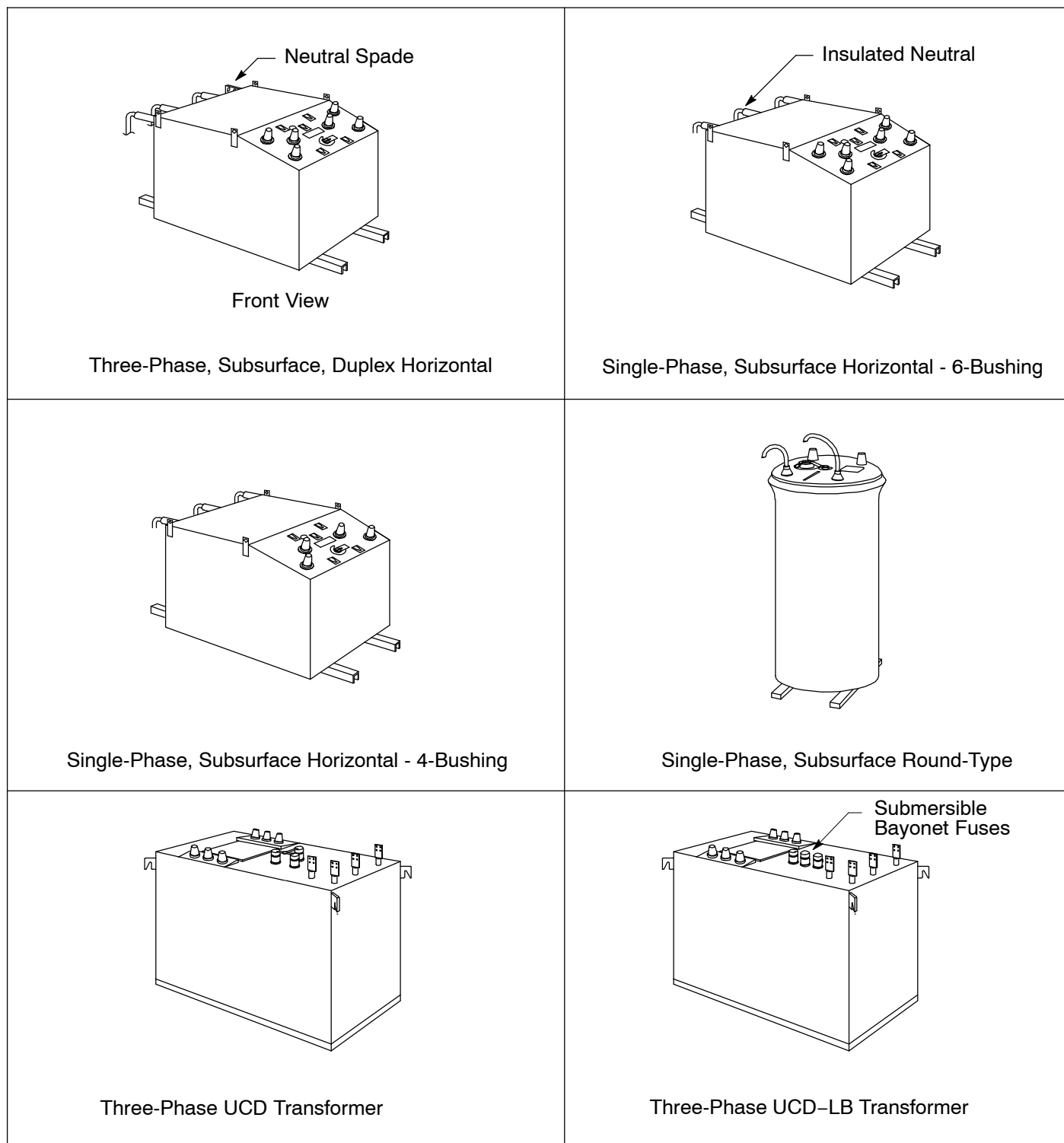

Figure 5
Subsurface Transformers for Loop or Radial Application

Pictorial Index (continued)

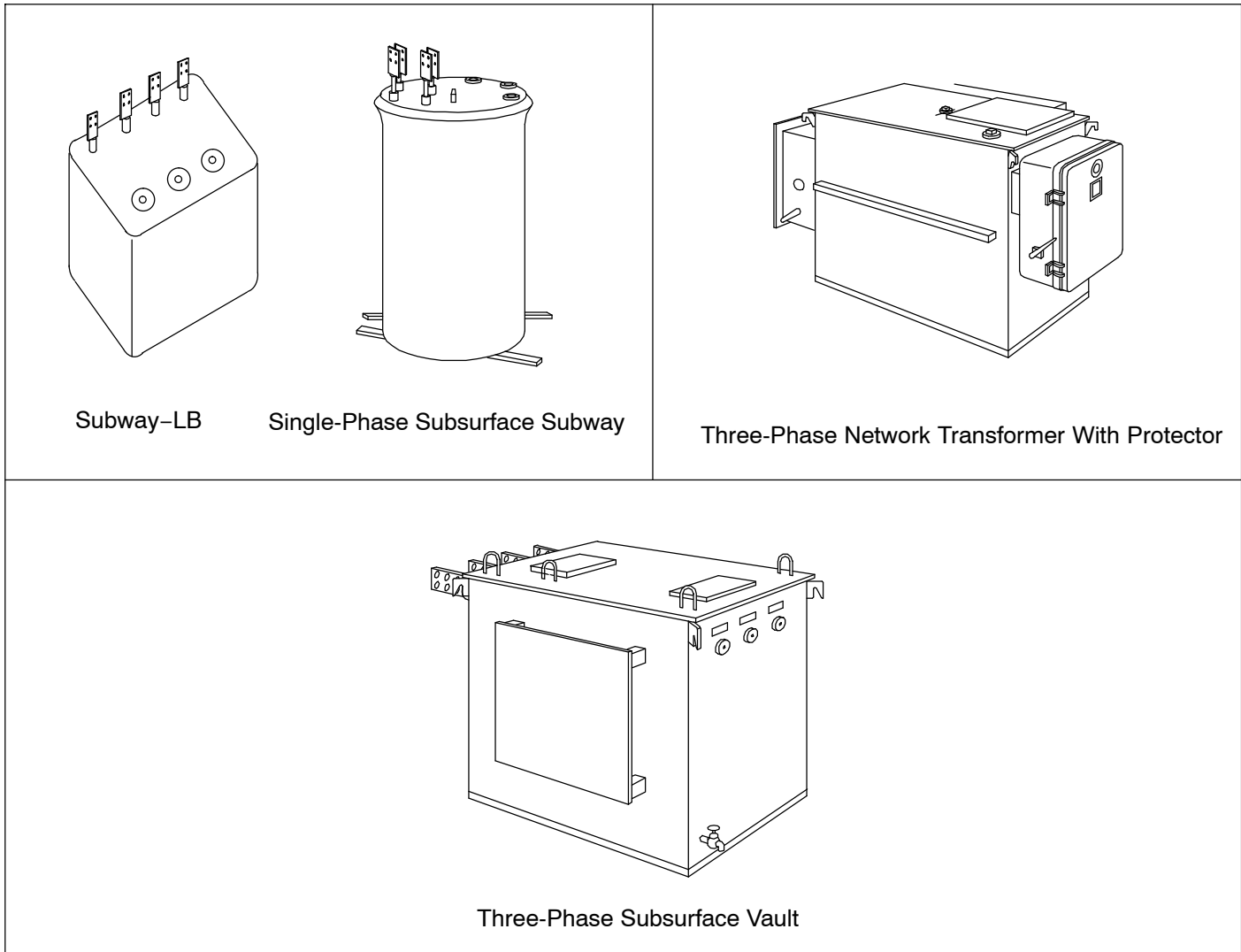

Figure 6
Subsurface Transformers for Radial Application

Revision Notes

Revision 25 has the following changes:

1. Revised Table 13 on Page 8.